



L88R05 Series

5 V, 1 A Voltage-regulator ICs with Reset Function

Overview

The L88R05 Series is a series of low-saturation voltage regulator ICs that are equipped with a function that generates a reset signal when the power supply for a microcontroller system is turned on or off.

Applications

- Prevents malfunction when the microcontroller power supply is turned on or off.
- Designed to handle malfunction caused by momentary power interruptions.
- Suited for portable electronic equipment, mobile electronic equipment, and other battery-powered equipment with little capacity to handle fluctuation in input voltage; also suited for equipment with large fluctuations in the primary power supply.

Functions

- Power supply reset generation function; the reset threshold voltages are ranked.

~~L88R05C: $V_{RT} = 4.5$ V~~

L88R05D: $V_{RT} = 4.2$ V

~~L88R05E: $V_{RT} = 3.9$ V~~

- 5 V, 1 A output characteristics

Features

- Minimum I/O voltage difference is small (0.5 V typ.), making power conservation possible, and makes smaller heatsink and transformers possible.
- External capacitor for reset signal output delay time adjustment.
- Sink/source reset output provides compatibility with logic circuitry that has an internal pull-down resistor. Active pull-up facilitates noise suppression.
- Various types of protective circuits on chip (fold back current limiting, thermal protection).
- The package is the TO220-5H; this package facilitates designs for the radiation of heat during the mounting process.

■ Any and all SANYO products described or contained herein do not have specifications that can handle applications that require extremely high levels of reliability, such as life-support systems, aircraft's control systems, or other applications whose failure can be reasonably expected to result in serious physical and/or material damage. Consult with your SANYO representative nearest you before using any SANYO products described or contained herein in such applications.

■ SANYO assumes no responsibility for equipment failures that result from using products at values that exceed, even momentarily, rated values (such as maximum ratings, operating condition ranges, or other parameters) listed in products specifications of any and all SANYO products described or contained herein.

Package Dimensions

unit : mm

3079-T0220-5H

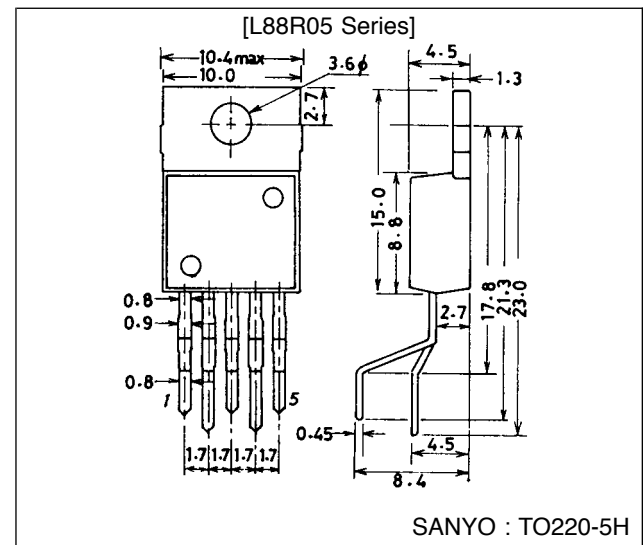

L88R05 Series

Specifications

Maximum Ratings at $T_a = 25^\circ\text{C}$

Parameter	Symbol	Conditions	Ratings	Unit
Maximum input voltage	$V_{IN\ max}$		18	V
Reset pin voltage	$V_{RES\ max}$		18	V
Allowable power dissipation	$Pd\ max$	$T_a \approx 25^\circ\text{C}$, independent IC	1.75	W
		$T_c \approx 50^\circ\text{C}$, ideal radiation of heat	20	W
Junction-to-ambient thermal resistance	θ_{j-a}		71.4	$^\circ\text{C/W}$
Junction-to-case thermal resistance	θ_{j-c}		5	$^\circ\text{C/W}$
Operating temperature	T_{opr}		-40 to +85	$^\circ\text{C}$
Storage temperature	T_{stg}		-55 to +150	$^\circ\text{C}$

Operating Conditions at $T_a = 25^\circ\text{C}$

Parameter	Symbol	Conditions	Ratings	Unit
Input voltage	V_{IN}		5.6 to 17	V
Output current	I_{OUT}		0 to 1	A
Reset output source current	I_{ORH}		0 to 200	μA
Reset output sink current	I_{ORL}		0 to 2	mA

Operating Characteristics at $T_j = 25^\circ\text{C}$, $V_{IN} = 8\text{ V}$, $I_{OUT} = 1\text{ A}$, $C_{OUT} = 47\ \mu\text{A}$ for specified circuits

Parameter	Symbol	Condition	min	typ	max	Unit
[Power Supply]						
Output voltage	V_{OUT}		4.85	5.0	5.15	V
Dropout voltage	V_{DROP1}			0.5	1.0	V
	V_{DROP2}	$I_{OUT} = 300\text{ mA}$		0.25	0.50	V
Line regulation	ΔV_{OLN}	$5.6\text{ V} \approx V_{IN} \approx 17\text{ V}$		10	70	mV
Load regulation	ΔV_{OLD}	$5\text{ mA} \approx I_{OUT} \approx 1\text{ A}$		50	150	mV
Peak output current	I_{OP}		1	1.8		A
Output short-circuit current	I_{OSC}			0.3	1.2	A
Current drain	I_{Q1}	$I_{OUT} = 0$		2.1	4	mA
	I_{Q2}			32	80	mA
Output noise voltage	V_{NO}	$10\text{ Hz} \approx f \approx 100\text{ kHz}$		70		μVrms
Output voltage temperature coefficient	$\Delta V_o/\Delta T_a$	$T_j = 25\text{ to }125^\circ\text{C}$		-0.5		$\text{mV}/^\circ\text{C}$
Ripple rejection ratio	R_{rej}	$f = 120\text{ Hz}$, $6\text{ V} \approx V_{IN} \approx 17\text{ V}$		60		dB
[Reset]						
High-level reset output voltage	V_{ORH}	$I_{ORH} = 200\ \mu\text{A}$, CD open	4.83	4.98	5.13	V
Low-level reset output voltage	V_{ORL}	$I_{ORL} = 2\text{ mA}$, CD grounded		100	200	mV
Reset threshold voltage	V_{RT}	C-rank	4.3	4.5	4.7	V
		D-rank	4.0	4.2	4.4	V
		E-rank	3.7	3.9	4.1	V
Reset hysteresis voltage	V_{hys}		50	100	200	mV
Output delay time	t_d	$C_d = 0.1\ \mu\text{F}$	7.5	10	12.5	ms

Pin Assignments

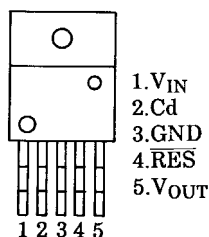

Top view

L88R05 Series

Equivalent Circuit Block Diagram

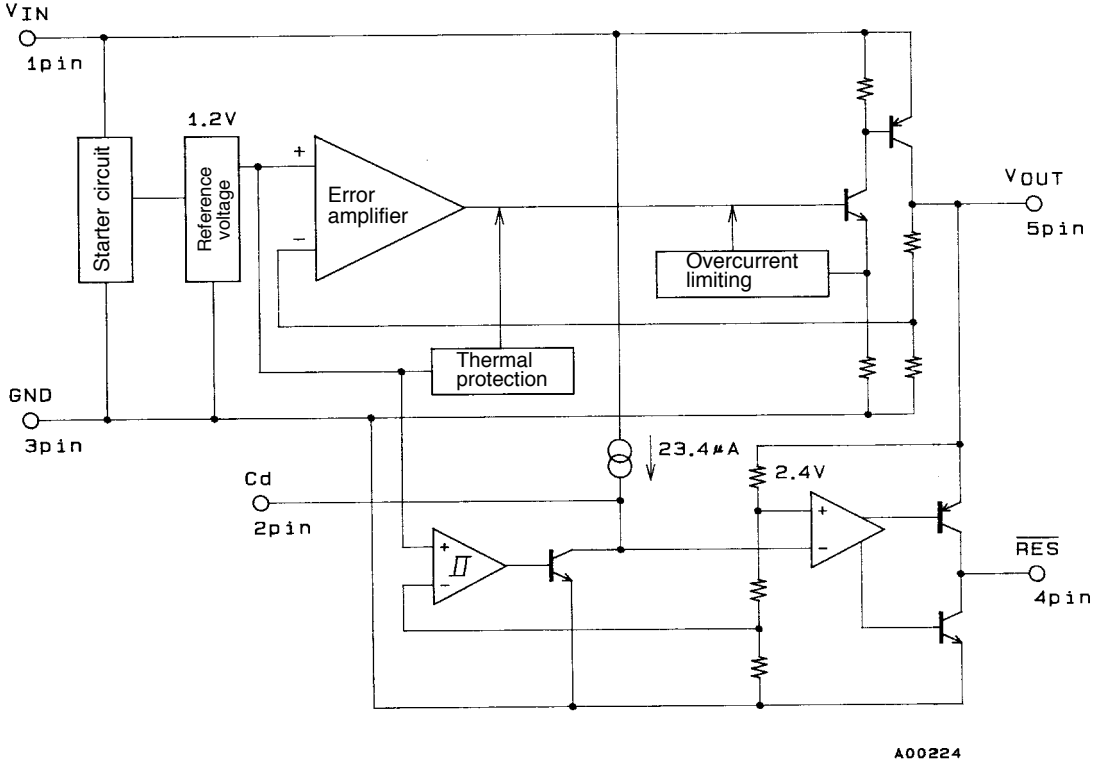

Measurement Circuit

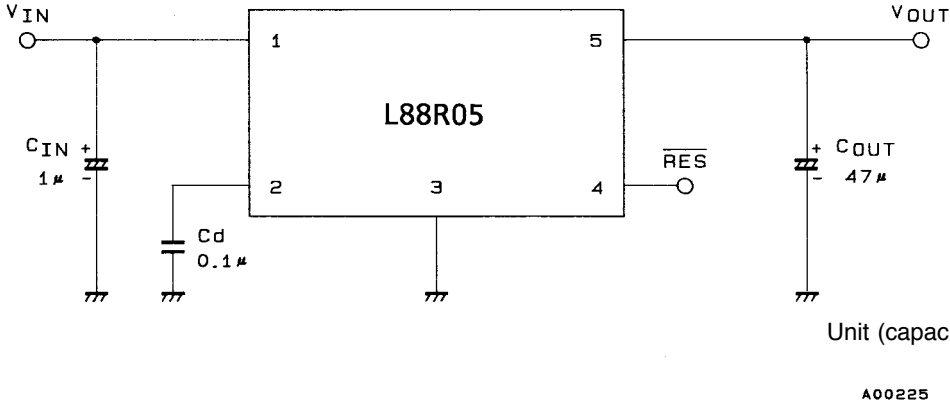

Unit (capacitance: F)

Sample Application Circuit

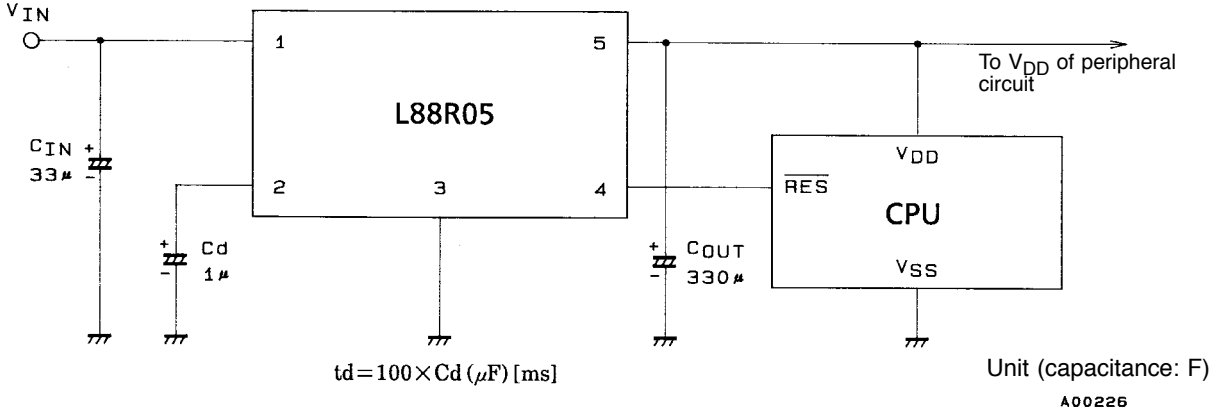

Notes:

1. Set C_{OUT} to be $47 \mu F$ or greater and select it according to the applications.
2. Use the capacitors for C_{OUT} and C_d with high-temperature stability.

L88R05C's Reset Operation

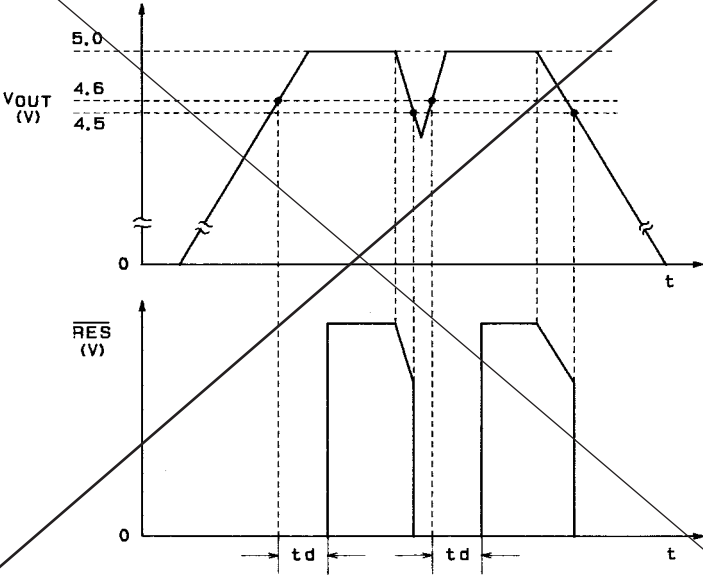

L88R05 Series

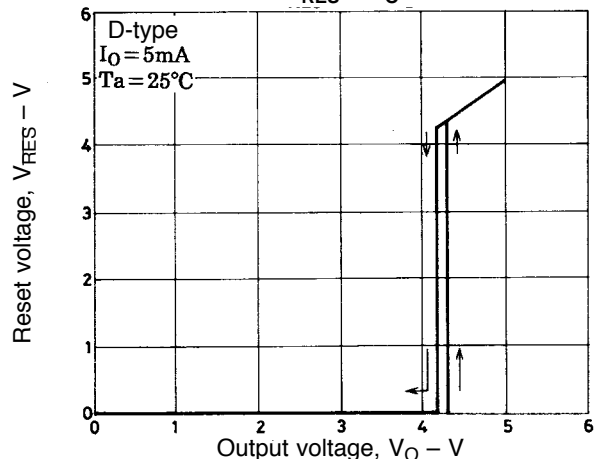
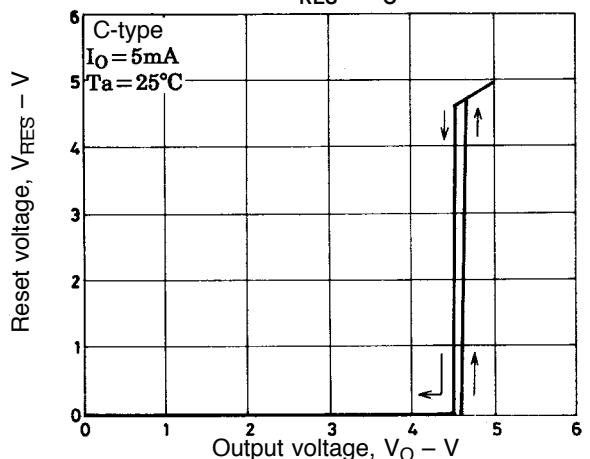
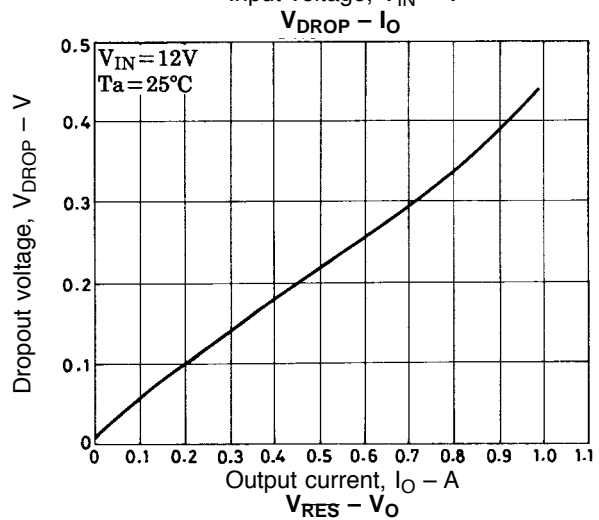
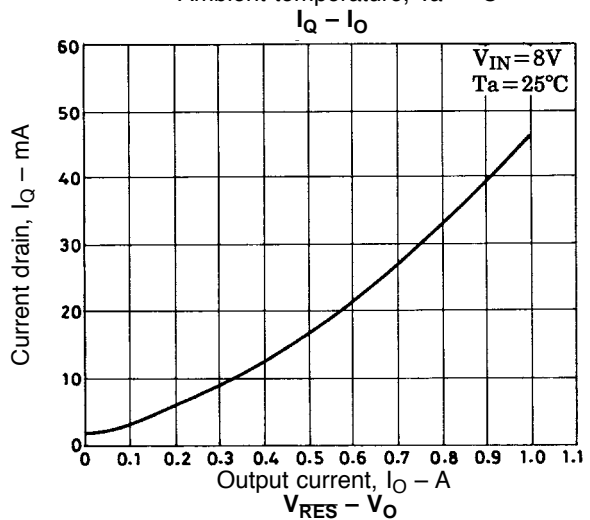
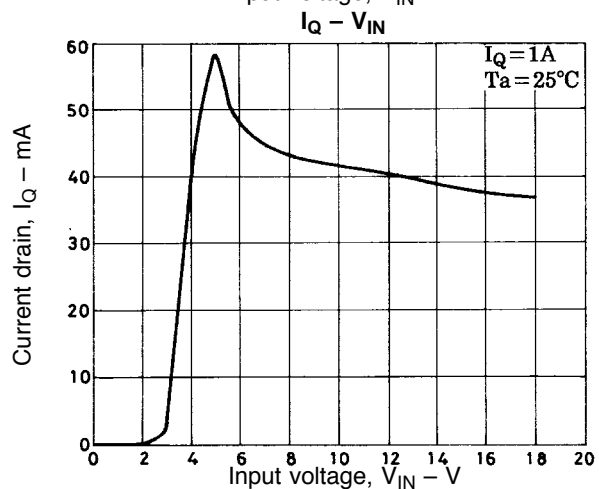
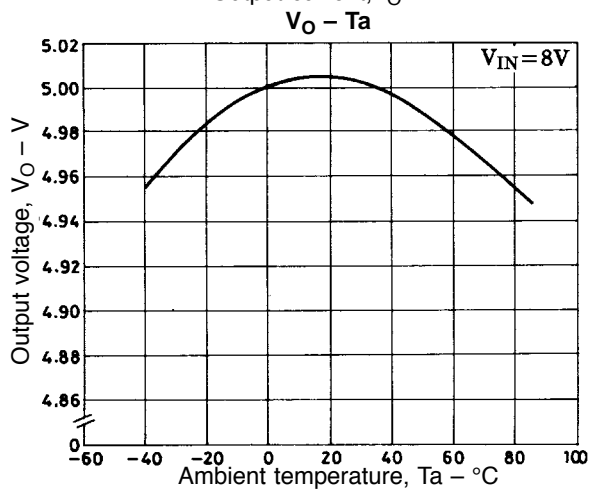
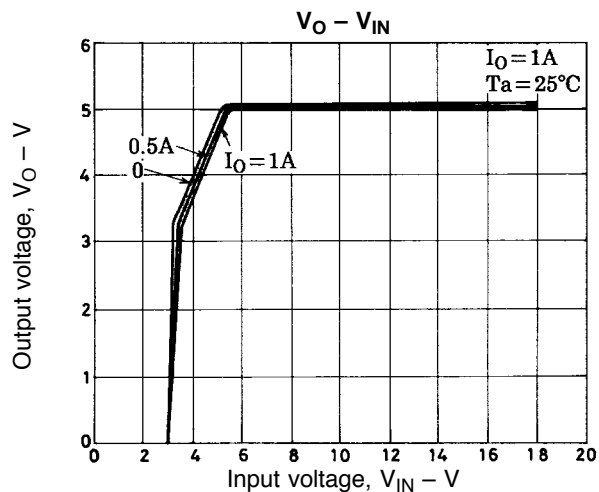
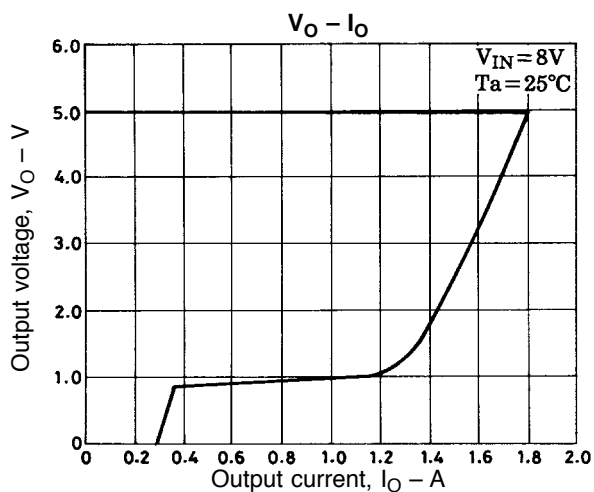

L88R05 Series

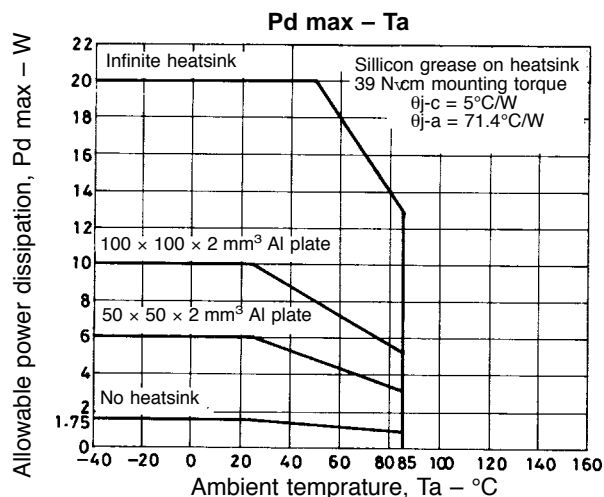
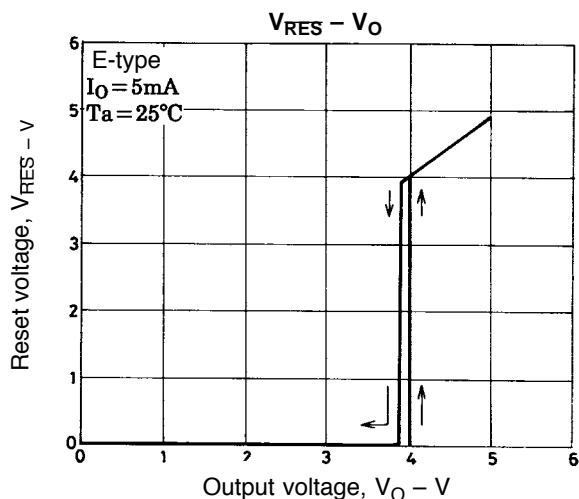

- Specifications of any and all SANYO products described or contained herein stipulate the performance, characteristics, and functions of the described products in the independent state, and are not guarantees of the performance, characteristics, and functions of the described products as mounted in the customer's products or equipment. To verify symptoms and states that cannot be evaluated in an independent device, the customer should always evaluate and test devices mounted in the customer's products or equipment.
- SANYO Electric Co., Ltd. strives to supply high-quality high-reliability products. However, any and all semiconductor products fail with some probability. It is possible that these probabilistic failures could give rise to accidents or events that could endanger human lives, that could give rise to smoke or fire, or that could cause damage to other property. When designing equipment, adopt safety measures so that these kinds of accidents or events cannot occur. Such measures include but are not limited to protective circuits and error prevention circuits for safe design, redundant design, and structural design.
- In the event that any or all SANYO products (including technical data, services) described or contained herein are controlled under any of applicable local export control laws and regulations, such products must not be exported without obtaining the export license from the authorities concerned in accordance with the above law.
- No part of this publication may be reproduced or transmitted in any form or by any means, electronic or mechanical, including photocopying and recording, or any information storage or retrieval system, or otherwise, without the prior written permission of SANYO Electric Co., Ltd.
- Any and all information described or contained herein are subject to change without notice due to product/technology improvement, etc. When designing equipment, refer to the "Delivery Specification" for the SANYO product that you intend to use.
- Information (including circuit diagrams and circuit parameters) herein is for example only; it is not guaranteed for volume production. SANYO believes information herein is accurate and reliable, but no guarantees are made or implied regarding its use or any infringements of intellectual property rights or other rights of third parties.

This catalog provides information as of October, 1996. Specifications and information herein are subject to change without notice.